



**Coimisiún na Scrúduithe Stáit**  
**State Examinations Commission**

**Leaving Certificate 2019**

**Marking Scheme**

**Chemistry**

**Ordinary Level**

## **Note to teachers and students on the use of published marking schemes**

Marking schemes published by the State Examinations Commission are not intended to be standalone documents. They are an essential resource for examiners who receive training in the correct interpretation and application of the scheme. This training involves, among other things, marking samples of student work and discussing the marks awarded, so as to clarify the correct application of the scheme. The work of examiners is subsequently monitored by Advising Examiners to ensure consistent and accurate application of the marking scheme. This process is overseen by the Chief Examiner, usually assisted by a Chief Advising Examiner. The Chief Examiner is the final authority regarding whether or not the marking scheme has been correctly applied to any piece of candidate work.

Marking schemes are working documents. While a draft marking scheme is prepared in advance of the examination, the scheme is not finalised until examiners have applied it to candidates' work and the feedback from all examiners has been collated and considered in light of the full range of responses of candidates, the overall level of difficulty of the examination and the need to maintain consistency in standards from year to year. This published document contains the finalised scheme, as it was applied to all candidates' work.

In the case of marking schemes that include model solutions or answers, it should be noted that these are not intended to be exhaustive. Variations and alternatives may also be acceptable. Examiners must consider all answers on their merits, and will have consulted with their Advising Examiners when in doubt.

## **Future Marking Schemes**

Assumptions about future marking schemes on the basis of past schemes should be avoided. While the underlying assessment principles remain the same, the details of the marking of a particular type of question may change in the context of the contribution of that question to the overall examination in a given year. The Chief Examiner in any given year has the responsibility to determine how best to ensure the fair and accurate assessment of candidates' work and to ensure consistency in the standard of the assessment from year to year. Accordingly, aspects of the structure, detail and application of the marking scheme for a particular examination are subject to change from one year to the next without notice.

## Introduction

**In considering the marking scheme the following should be noted.**

1. In many cases only key phrases are given which contain the information and ideas that must appear in the candidate's answer in order to merit the assigned marks.
2. The descriptions, methods and definitions in the scheme are not exhaustive and alternative valid answers are acceptable.
3. The detail required in any answer is determined by the context and the manner in which the question is asked, and by the number of marks assigned to the answer in the examination paper and, in any instance, therefore, may vary from year to year.
4. The bold text indicates the essential points required in the candidate's answer. A double solidus (//) separates points for which separate marks are allocated in a part of the question. Words, expressions or statements separated by a solidus (/) are alternatives which are equally acceptable for a particular point. A word or phrase in bold, given in brackets, is an acceptable alternative to the preceding word or phrase. Note, however, that words, expressions or phrases must be correctly used in context and not contradicted, and where there is evidence of incorrect use or contradiction, the marks may not be awarded. Cancellation may apply when a candidate gives a list of correct and incorrect answers.
5. In general, names and formulae of elements and compounds are equally acceptable except in cases where either the name or the formula is specifically asked for in the question. However, in some cases where the name is asked for, the formula may be accepted as an alternative.
6. There is a deduction of one mark for each arithmetical slip made by a candidate in a calculation.
7. Bonus marks at the rate of 10% of the marks obtained will be given to a candidate who answers entirely through Irish and who obtains less than 75% of the total marks.

Candidates are required to attempt 8 questions in total. All questions carry equal marks (50).

### Section A

At least two questions must be answered from this section.

### Section B











At least five questions must be answered from this section.

Eight items to be answered in **Question 4**. Six marks allocated to each item and one additional mark to be added to each of the first two items for which the highest marks are awarded.

Note that candidates who attempt **Question 10** are required to answer two of the parts (a), (b) and (c) and candidates who attempt **Question 11** are required to answer two of the parts (a), (b) and (c) where candidates who answer part (c) may choose **A** or **B**.

Annotations used in marking

Fully correct or fully incorrect responses may not be annotated.

Annotation	Meaning
	correct
	incorrect
	mathematical slip
	reverse order
	surplus answer or part of answer
	blank page or part of page
	cancellation /contradiction
	part of answer of significance
	incorrect charge, subscript, etc
	key word, phrase omitted

## Section A

At least two questions must be answered from this section.

### QUESTION 1

- (a) IDENTIFY:
- (i) **dropping funnel / tap funnel**  
[Allow separating funnel.][Burette or funnel unacceptable.]
  - (ii) **water / H<sub>2</sub>O**
  - (iii) **calcium dicarbide / calcium(II) carbide / CaC<sub>2</sub>** (5 + 3 + 3)  
[Allow carbide.]
- (b) (i) DESCRIBE: **effervescence / fizzing / bubbling / flask gets hot / steam / white smoke (vapour) / cloudy (milky) appearance / bubbles in collecting trough (test-tube) / solid disappears (disappearing) / dirty brown liquid produced** (6)
- (ii) WHY: **impure / contain air / contain oxygen / contain nitrogen / do not contain enough or any ethyne** (6)
- (c) (i) WHAT: **brown (red, orange, yellow) colour // disappears (decolorises, fades)** (2 × 3)  
[Accept brown to yellow for brown fades.]  
[Allow colours reversed for (3).]
- (ii) WHAT: **ethyne unsaturated / multiple C-C bond present in ethyne** (6)  
[Allow **triple bond** in ethyne and **double or triple bond** present.]
- (iii) GIVE: **ethene (C<sub>2</sub>H<sub>4</sub>, CH<sub>2</sub>=CH<sub>2</sub>) / any alkene or alkyne (other than ethyne)** (3)
- (d) WHAT: **bright (yellow, luminous, sooty, smoky) flame / smuts (soot, black smoke)** (6)
- (e) GIVE: **oxyacetylene flame / oxy-acetylene metal cutting / oxy-acetylene welding (flame) / ripening bananas** (6)

## QUESTION 2

(a) WHY: **difficult to swirl contents / contents more easily spilled / contents lost by splashing / spatters (droplets) from burette escape / sloping sides better / straight sides don't keep contents inside as well as sloping sides** (5)

(b) WHAT: (i) rinse with **deionised (distilled, pure) water //**  
rinse with **sodium carbonate (Na<sub>2</sub>CO<sub>3</sub>) solution /**  
rinse with **solution pipette will hold** (2 × 3)  
[Allow (3) for correct responses in reverse order.]  
[Allow (3) for rinse with sodium carbonate (Na<sub>2</sub>CO<sub>3</sub>) only.]

(ii) **deionised (distilled, pure) water only** (3)  
[2<sup>nd</sup> rinsing cancels]

(c) STATE: **read at eye level / place a white (coloured) card behind scale (meniscus) / read bottom of meniscus / make sure space below tap full** (6)

(d) (i) GIVE: **pure / solid / water soluble / stable in air / high molecular mass / anhydrous / not oxidised by air / does not deliquesce (absorb water from air) / not hygroscopic / mass true (accurate) representation of number of moles present** (6)  
[Allow 'non-toxic' or 'cheap' or 'readily available' or 'enables known concentration to be obtained' for 3.]

(ii) EXPLAIN: solution of **known concentration** (6)

(e) (i) NAME: **methyl orange** (3)

(ii) STATE: **yellow (orange) to // red (pink, peach)** (2 × 3)  
[If there is no response for (i) marks can be given for (ii).]  
[Marks may be given for correct colours of a named incorrect indicator, e.g. litmus.]  
[Allow (3) for correct colours reversed (and matching a named indicator).]  
[(9) marks only available for correct indicator and correct colours in correct order.]

(f) CALCULATE: **0.11 mol l<sup>-1</sup>** (9)

$$\frac{25 \times 0.05}{1} = \quad (3)$$

$$\frac{22.6 \times M}{2} \quad (3)$$

$$M = \mathbf{0.11 \text{ mol l}^{-1}} \quad (3)$$

or

$$\frac{25 \times 0.05}{1000} = \mathbf{1.25 \times 10^{-3} \text{ moles Na}_2\text{CO}_3} \quad (3)$$

$$1.25 \times 10^{-3} \times 2 = \mathbf{2.5 \times 10^{-3} \text{ moles HCl}} \quad (3)$$

$$M = \frac{2.5 \times 10^{-3} \times 1000}{22.6} = \mathbf{0.11 \text{ mol l}^{-1}} \quad (3)$$

If first 6 not awarded formula may be awarded 3.

### QUESTION 3

(a) WHY: to **remove suspended (insoluble) solids** / so that **only dissolved solids are left** in A (5)  
 [Allow 3 for remove solids (impurities, dirt, stones, grit, seeds, small pieces of plant, etc)]

(b) NAME: **burette / pipette / large syringe / graduated cylinder** (6)  
 [Beaker unacceptable.]

(c) (i) NAME: **evaporating basin (dish) / beaker**  
 [Allow crucible.]

(ii) GIVE: **use gloves (tongs) to handle hot equipment / avoid burns from hot equipment / use hotplate instead of Bunsen / wear safety glasses (white coat, PPE) / tie back hair / etc** (6 + 3)

(d) (i) DESCRIBE: (3 × 3)

Method 1	Method 2	Method 3	
clean a <b>platinum (nichrome) wire* (rod, probe)</b> in concentrated hydrochloric acid (HCl) / <b>clean platinum wire</b>	<b>soak wood (splint, stick)</b> overnight in water / <b>use damp (wet) wood (splint, stick)</b>	<b>prepare</b> a solution of the <b>salt in water and ethanol (propanol)</b>	(3)
<b>dip rod in salt</b>	<b>dip splint (stick) in salt</b>	<b>spray</b> solution	(3)
<b>hold salt in (over) hot (blue) part of flame (Bunsen) / observe colour of flame</b>	<b>hold salt in (over) hot (blue) part of flame (Bunsen) / observe colour of flame</b>	<b>onto (into) hot (blue) part of flame (Bunsen) / observe colour of flame</b>	(3)

\*[Allow 'inoculating loop', or 'spatula' for 'platinum wire'.]  
 [Clear labelled diagram for some or all points acceptable.]

(ii) WHAT: **yellow (amber, orange)** (6)

(e) (i) WHAT: **65.7 – 66 g in 200 cm<sup>3</sup>** (3)

$201.1 - 135.4 = 65.7 \text{ g in } 200 \text{ cm}^3$ (3)
---

(ii) CALCULATE: **328.5 – 330 g l<sup>-1</sup>** (6)

$65.7 \times 5$ (3)
$= 328.5 \text{ g l}^{-1}$ (3)

(f) WHAT: **white** (6)

## Section B

### QUESTION 4

Eight items to be answered. Six marks to be allocated to each item and one additional mark to be added to each of the first two items for which the highest marks are awarded.

(a) NAME: Niels Bohr (6)

(b) WHAT: inversely (indirectly, reciprocally) proportional / vary inversely (indirectly, reciprocally) /  $pV = \text{constant}$  /  $p \propto 1/V$  /  $V \propto 1/p$  (6)  
[Allow (3) for indirect or inverse or pressure increases as volume decreases or pressure decreases as volume increases or (3) for Boyle's law.]

(c) SUPPLY: protons // neutrons (2 × 3)

(d) (i) WHICH: oxygen (O, O<sub>2</sub>) (3)

(ii) GIVE: oxygen gains electrons / oxygen ends up with negative charge (3)

(e) WRITE:  $\text{Na} + \text{H}_2\text{O} \rightarrow \text{NaOH} + \frac{1}{2}\text{H}_2$  /  $2\text{Na} + 2\text{H}_2\text{O} \rightarrow 2\text{NaOH} + \text{H}_2$  (3)  
FORMULAE: (3); BALANCING OF CORRECT FORMULAE: (3)

(f) WHAT: enzyme (6)

(g) CALCULATE: 80.2 % (6)

$$M_r = 65 + 16 = 81 \quad (3)$$

$$\% \text{Zn} = \frac{65}{81} \times 100 = 80.2 \% \quad (3)$$

(h) WHAT: the tendency of the fuel to resist (cause) knocking (pinking, autoignition, pre-ignition) / indication of how well a fuel resists (causes) knocking (pinking, autoignition, pre-ignition) (6)

(i) WHAT: breakdown / consumption / digestion / oxidation // biological / biochemical / by bacteria / by microorganisms / by activated sludge (2 × 3)

(j) WHAT: temporary / hydrogencarbonate (6)

(k) A WHICH: CO<sub>2</sub> // SO<sub>2</sub> (2 × 3)

or

B WHICH: iron // copper (2 × 3)



**QUESTION 5**

(a) WHAT: **cannot be broken down into simpler substance(s) chemically / composed of atoms with same number of protons (atomic number)** (5)

(b) DRAW: (i)

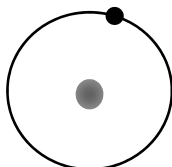

(3)

(ii)

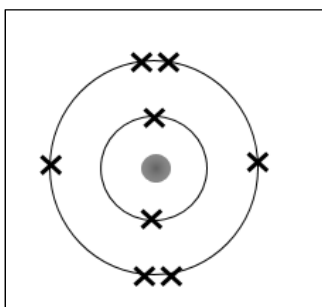

[Pairs of electrons or single electrons acceptable.]

(6)

(c) (i) DEFINE: **relative (measure of) attraction / number expressing (giving) attraction // for shared electrons / for shared pair / for electrons in a covalent bond** (2 × 3)

(ii) WRITE: H: 2.20 and O: 3.44 (3)

(iii) USE: **polar covalent** (3)

(iv) DRAW:

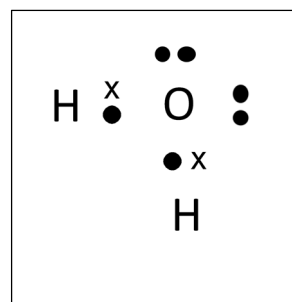
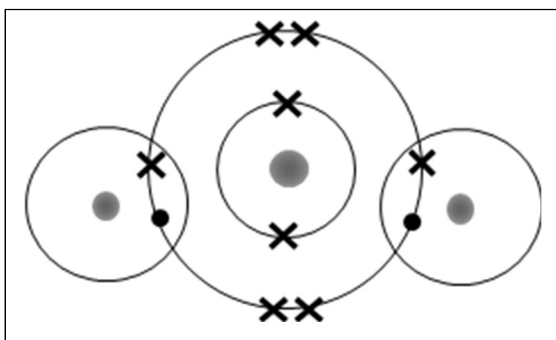

Exactly 2 lone pairs or exactly 4 non-bonded electrons in valence shell of oxygen (3)

Exactly 2 bond pairs in valence shell of oxygen (3)

Inner electrons of oxygen need not be shown

(d) (i) WHAT: **ionic** (6)

(ii) WOULD: **yes** (3)

(iii) WOULD: **yes** (3)

(e) WHY: **unknown / not discovered yet / unreactive** (6)

## QUESTION 6

(a) TO WHICH: **alkane(s)** (5)

(b) GIVE: **A: methane**  
**B: ethene**  
**C: butane**  
**D: benzene** (3 × 4)

(c) (i) WHAT: **liquid (liquefied) petroleum gas**  
(ii) WHICH: **C (CH<sub>3</sub>CH<sub>2</sub>CH<sub>2</sub>CH<sub>3</sub>, C<sub>4</sub>H<sub>10</sub>, butane)**  
(iii) WHAT: **CH<sub>3</sub>CH<sub>2</sub>CH<sub>3</sub> (C<sub>3</sub>H<sub>8</sub>, propane)** (6 + 6 + 3)

(d) WHICH: (i) **A (CH<sub>4</sub>, methane)**  
(ii) **D (C<sub>6</sub>H<sub>6</sub>, benzene)** (6 + 3)

(e) INDICATE: (i) ethanol **end of test-tube** (3)  
(ii) Al<sub>2</sub>O<sub>3</sub> **middle of test-tube** (3)  
(iii) heat **middle of test-tube** (3)

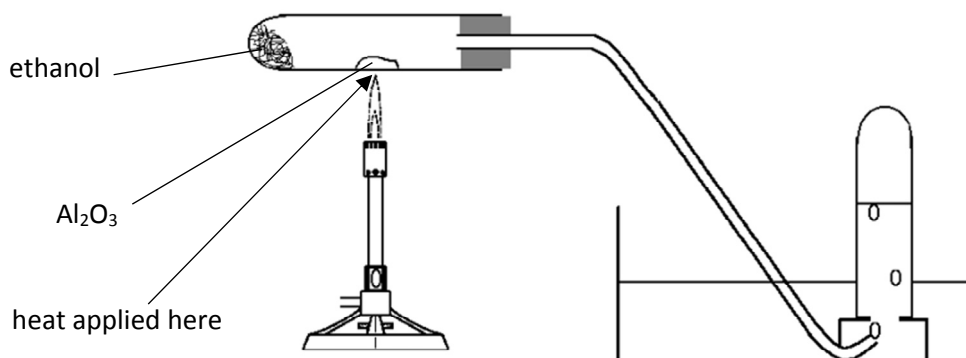

## QUESTION 7

(a) (i) PLOT:

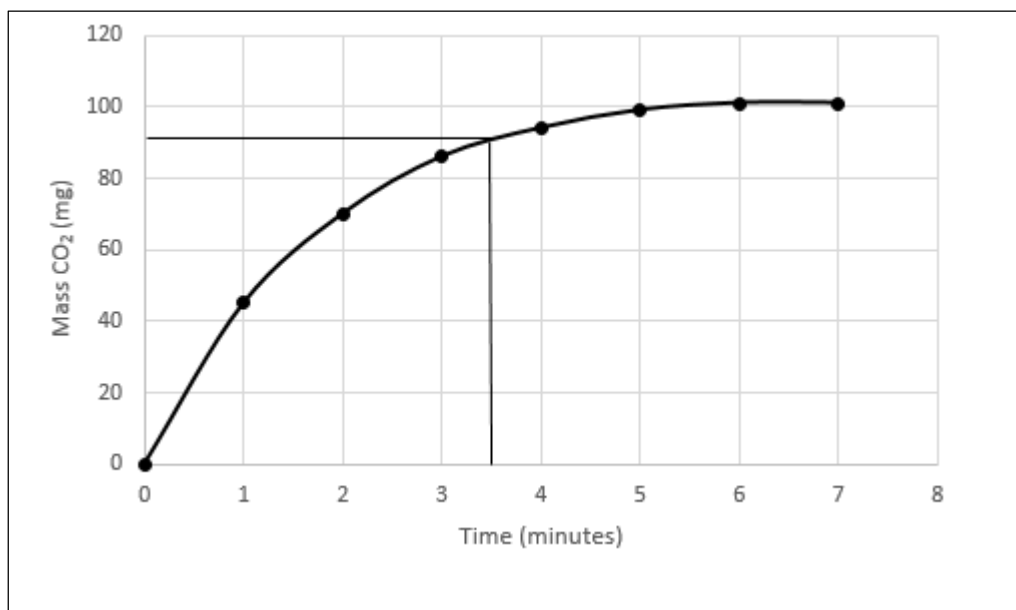

tick once for axes correctly labelled with unit (mg and minute)

or quantity (mass and time)

(3)

tick once for axes correctly scaled

(3)

tick once for 6 points correctly plotted

(3)

tick once for 2 further points correctly plotted

(3)

[Minus 3 if graph not on graph paper.]

smooth curve correctly drawn through points and (0, 0)

(3)

(ii) USE: 90 - 92 mg (0.09 to 0.092 g)

(6)

(b) DOES: rate decreases (slows)

(3)

GIVE: eggshell (solid, CaCO<sub>3</sub>, reactant) used up /  
acid (HCl) becomes less concentrated (used up) /  
reactants (substances, chemicals) used up /  
concentration of reactants (substances, chemicals) decreases

(3)

(c) (i) SUGGEST: mortar //  
and pestle  
[Allow 3 for grinder, hammer, etc]

(3 + 3)

(ii) PREDICT: rate increased (speeded up) / reaction faster

(6)

EXPLAIN: larger (increased) surface area for reaction /  
liquid (acid) makes contact with more solid (eggshell, CaCO<sub>3</sub>)

(6)

(d) STATE: rate increased (faster)

(5)

### QUESTION 8

- (a) NAME: W: **methanol //**  
X: **methanal (formaldehyde) //**  
Y: **methanoic (formic) acid** (3 × 3)  
[Take names in order of question unless names clearly linked to letters W, X and Y.]

- (b) WHICH: (i) **Y (HCOOH, methanoic acid, formic acid)**  
(ii) **W (CH<sub>3</sub>OH, methanol)**  
(iii) **X (HCHO, methanal, formaldehyde)** (5 + 3 + 3)

- (c) DRAW: (6)

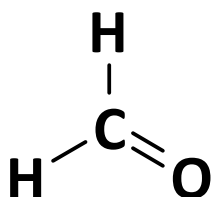

[Hs need not be shown explicitly.][Allow 3 for a molecule with a carbonyl group.]

- (d) (i) WHICH: **W / methanol**  
(ii) WHAT: **planar / trigonal** (6 + 3)

- (e) (i) STATE: **oxidation / redox //**  
(ii) IDENTIFY: **acidified KMnO<sub>4</sub> (MnO<sub>4</sub><sup>-</sup>, manganate) / acidified K<sub>2</sub>CrO<sub>4</sub> (CrO<sub>4</sub><sup>2-</sup>, chromate) / acidified K<sub>2</sub>Cr<sub>2</sub>O<sub>7</sub> (Cr<sub>2</sub>O<sub>7</sub><sup>2-</sup>, dichromate) /** (6 + 3)

- (f) COPY, COMPLETE & BALANCE:  $\text{CH}_3\text{OH} + 1\frac{1}{2}\text{O}_2 \rightarrow \text{CO}_2 + 2\text{H}_2\text{O}$   
FORMULAE: (3); BALANCING: (3)

### QUESTION 9

(a) DEFINE: (i) gives hydrogen (hydronium) ions ( $\text{H}^+$ ,  $\text{H}_3\text{O}^+$ ) in aqueous solution / proton (hydrogen ion,  $\text{H}^+$ ) donor (6)

(ii) gives hydroxyl ions ( $\text{OH}^-$ ) in aqueous solution / proton (hydrogen ion,  $\text{H}^+$ ) acceptor (6)

(b) (i) DEFINE:  $\text{pH} = -\log [\text{H}^+]$  /  $\text{pH} = -\log [\text{H}_3\text{O}^+]$  (6)  
[Allow  $-\log (3)$ ]

(ii) COPY & COMPLETE:  $\text{pH} + \text{pOH} = 14$  /  $\text{pH} = 14 - \text{pOH}$  / 14 (3)

(iii) WHAT: 7 (3)

(iv) CALCULATE: 12.0 (6)

$\text{pOH} = -\log 0.01 = 2.0$	(3)
---------------------------------	-----

$\text{pH} = 14 - \text{pOH} = 14 - 2.0 = 12.0$	(3)
---	-----

(c) (i) WHAT: suspended particles clump together / addition of  $\text{Al}_2(\text{SO}_4)_3$  (aluminium sulfate, polyelectrolytes) / suspended particles sink (settle) / suspended particles separated (removed) /

(ii) WHAT: to kill microorganisms (bacteria, pathogens) / to sterilise the water / to prevent water becoming re-contaminated after purification

(iii) WHY: to prevent tooth decay / to strengthen tooth enamel (6 + 6 + 3)

(iv) WHAT: lime ( $\text{CaO}$ ) /  $\text{Ca}(\text{OH})_2$  / a base ( $\text{NaOH}$ , etc) (5)

**QUESTION 10:** Answer any **two** of the parts (a), (b) and (c).

- (a) WRITE:
- 1 crude oil //
  - 2 hydrocarbon //
  - 3 base //
  - 4 top //
  - 5 smaller //
  - 6 larger //
  - 7 residue

FIRST SIX: (7 + (6 × 3))

- (b) (i) EXPLAIN: state where **forward and reverse** reactions //  
**have equal rates** (4 + 3)

or

- state where **concentrations of reactants and products** //  
**is constant** (4 + 3)

- (ii) IS: **exothermic** (3)

- GIVE:  **$\Delta H$  negative / combustion reaction** (3)

- (iii) WRITE:  $K_c = \frac{[\text{SO}_3]^2}{[\text{SO}_2]^2[\text{O}_2]}$  (6)

[numerator correct (3) and denominator correct (3); inverted (3)]

- (iv) SUPPLY:
- 1 **temperature / pressure / concentration** of any reactant or product //
  - 2 **pressure / temperature / concentration** of any reactant or product //
  - 3 **reduce / counteract / minimise / cancel**
- (3 × 2)

[Same answer for 1 and 2 not acceptable.]

(c) (i) WHAT: **108 g** (3)

HOW MANY: **0.1 moles Ag** (6)

$$n = \frac{m}{A_r} = \frac{10.8}{108} = 0.1 \text{ moles silver} \quad (6)$$

(ii) WHAT: **2:1 / 2 to 1 / two silver for one H<sub>2</sub> / one H<sub>2</sub> for (to) two silver** (3)

HOW MANY: **0.05 moles H<sub>2</sub>** (3)

$$0.1 \text{ moles Ag} \Rightarrow 0.05 \text{ moles H}_2 \quad (3)$$

WHAT VOLUME: **1.12 litres H<sub>2</sub>** (3)

$$0.05 \times 22.4 = 1.12 \text{ litres H}_2 \quad (3)$$

(iii) WHAT MASS: **12.4 g Ag<sub>2</sub>S** (7)

$$M_r = (108 + 108 + 32) = 248 \quad (3)$$

$$0.05 \text{ moles Ag}_2\text{S} \quad (2)$$

$$0.05 \times 248 = 12.4 \text{ g Ag}_2\text{S} \quad (2)$$

**QUESTION 11:** Answer any **two** of the parts (a), (b) and (c).

- (a) DEFINE: (i) **number (how many, quantity, amount) of protons** in an atom of an element / **number of protons or electrons** in an atom of an element (6)
- (ii) **number (how many, quantity, amount) of protons and neutrons** in an atom of an element (6)
- (iii) STATE: **12** (3)
- (iv) HOW MANY: **13** (3)
- (v) WHAT: **isotope(s)** (3)
- (vi) HOW MANY: **12** (4)
- (b) HOW MANY:  **$6 \times 10^{23}$**  (6)
- WHICH: (i) **methane** (3)
- (ii) **hydrogen** (3)
- (iii) **helium** (3)
- WHICH: **helium** (3)
- EXPLAIN: helium has a **stable electron arrangement (configuration)** /  
helium is a **noble (inert) gas** /  
helium **in Group 18 (Group 8, Group VIII, Group 0)** /  
helium **has a full outer shell** (3)
- SUGGEST: **flammable / explosive / dangerous** (4)



(c) Answer part **A** or part **B**.

**A**

- (i) WHAT: **78% ( $\pm$  2%)** (6)
- (ii) GIVE: **lightning /  
nitrogen-fixing bacteria / legumes (named legume plant)** (6)  
[Allow bacteria (3)]
- (iii) HOW: **through (by) root / from soil / in water absorbed by plant / active transport /  
in solution** (3)
- (iv) HOW: **eaten** (3)
- (v) WHAT: **protein manufacture / growth / repair of tissue (cells)** (3)
- (vi) WHY: **nitrogen returned to atmosphere / constant concentration of nitrogen  
in atmosphere / nitrogen never gets used up / nitrogen being  
converted from one compound (form) into another / process keeps  
repeating / nitrogen never removed from the system of reactions, etc** (4)

*or*

**B**

- (i) EXPLAIN: **oxidation (reaction) of the metal (surface) / rusting //  
when exposed to air (water, dampness, acid, the environment)** (2 × 3)
- (ii) HOW: **iron corrodes (rusts) more easily / aluminium less easily corroded //  
oxide of aluminium adheres / oxide of iron (rust) flakes off** (2 × 3)
- (iii) HOW: **in blast furnace / in smelter //  
by reduction (reduced) //  
by coke (C, CO)** (3 × 3)
- (v) WHY: **very costly to produce from its ores / economical to recycle /  
uses a lot of electricity (energy, power) to produce from its ore /  
environmentally friendly to recycle / to avoid red mud from bauxite** (4)

BLANK PAGE



